

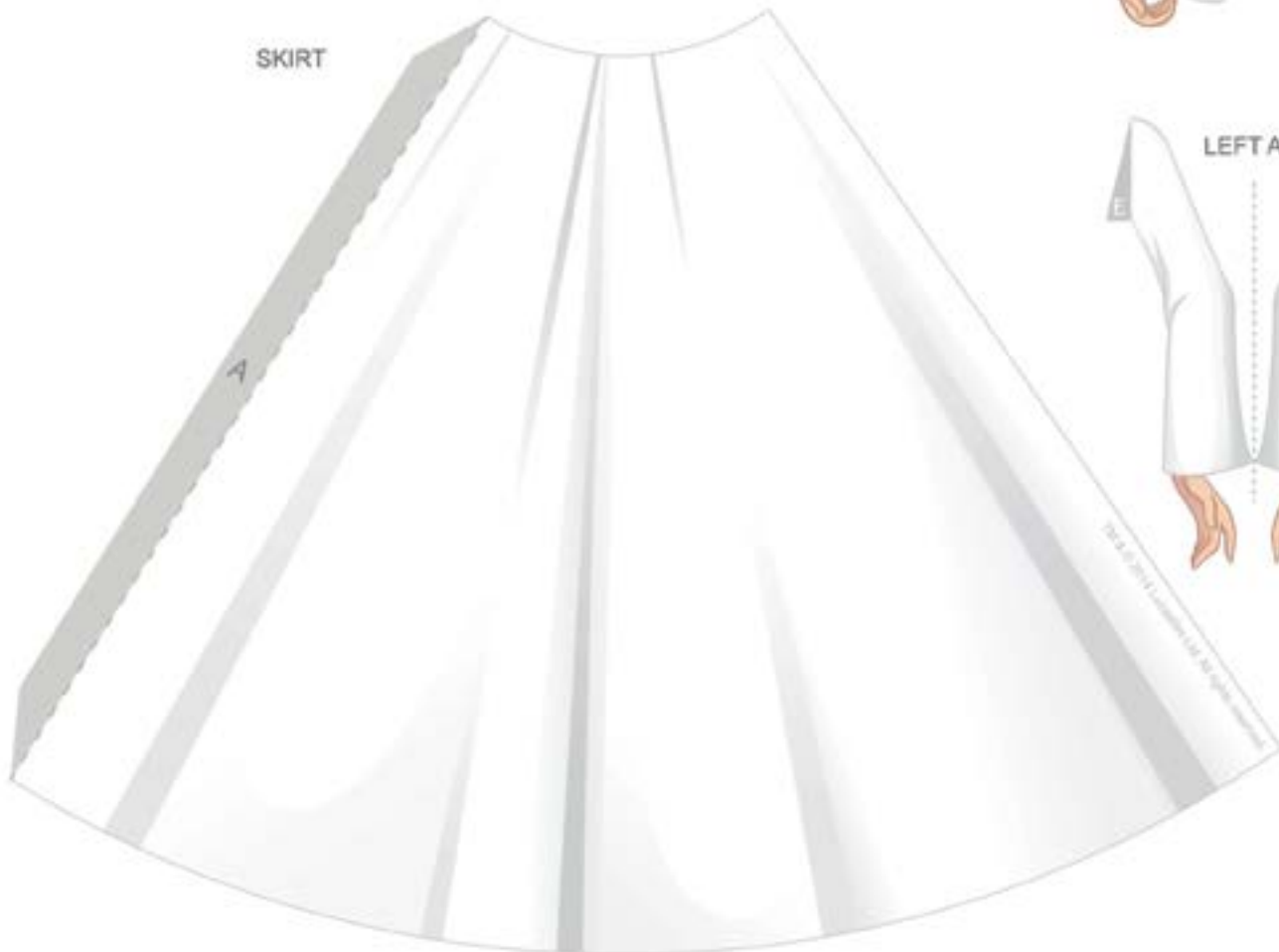

# PRINCESS LEIA PAPERCRAFT

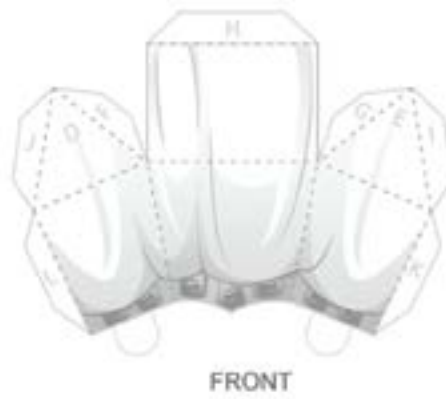



# PRINCESS LEIA PAPERCRAFT

## INSTRUCTIONS:

- 1** Print the template on regular paper or cardstock. Cut out each piece with a craft knife or scissors. Do not cut along the dashed lines — this is where you will fold the paper.
- 2** Line up Leia's back with her TORSO and glue them together so the design is two-sided. After the glue has dried, fold the bottom part of Leia's TORSO towards you along the blue dashed line. Then, fold Leia's face away from you along the gold line across her shoulders.
- 3** Take Leia's FRONT piece and fold along each dashed line. Make each fold away from you. Glue the G tab and F tab to the back, white side of Leia's FRONT.
- 4** Spread glue on the H tab of Leia's FRONT and press it into place on the H area on Leia's TORSO. Make sure her shoulders are lined up correctly.
- 5** After the glue dries, add glue to the I, J, K, and L tabs and press them into place. Hold the pieces together until the glue dries. You may need to use a pen or pencil inside the FRONT area to position the tabs just right.
- 6** Fold each of Leia's arms and glue them so the design is two-sided. Make sure they are lined up before the glue dries. Attach the arms to each side of Leia's TORSO under each shoulder by gluing the E tab to the E area and D tab to the D area.
- 7** With the printed side of the SKIRT facing you, glue tab A to the back of the SKIRT taking care to line up the edge of the SKIRT along the dotted line.
- 8** Place Leia's completed TORSO over her SKIRT and push down gently until snug. Center the seam of the SKIRT directly behind the back of her TORSO and glue the white tabs to the SKIRT.





# POLYMER CLAY YODA TEMPLATE

Use these templates as a guide to approximate the color, shapes, and sizes of the polymer clay pieces you use.

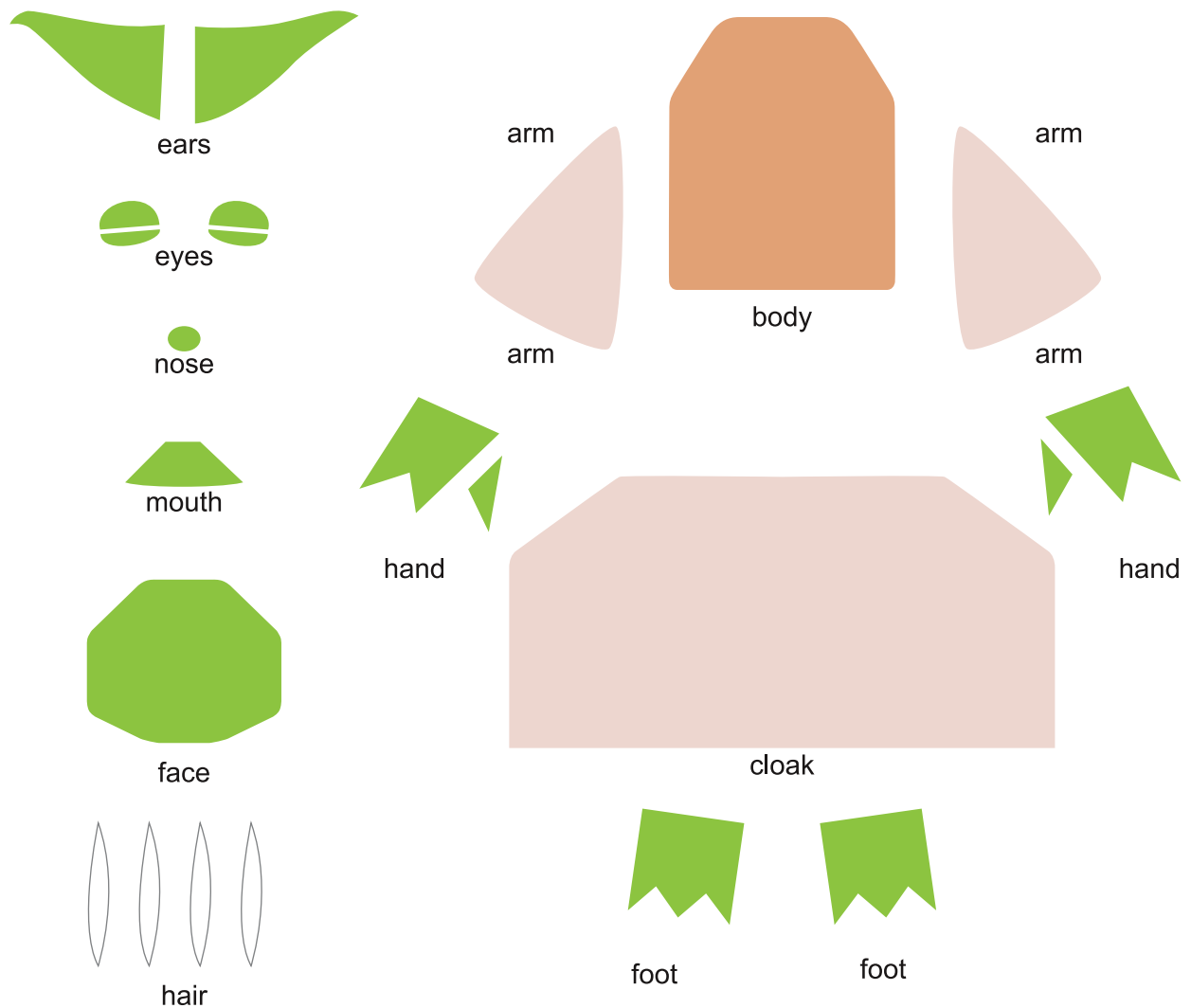

# POLYMER CLAY YODA TEMPLATE

## INSTRUCTIONS:

### MATERIALS NEEDED:

- Polymer clay colors (green, off-white, white, tan, brown)
- Clay tools, toothpicks or craft sticks for cutting

- 1** Cut the shapes you see here referring to the template on Page 1 for size, color, and shapes.

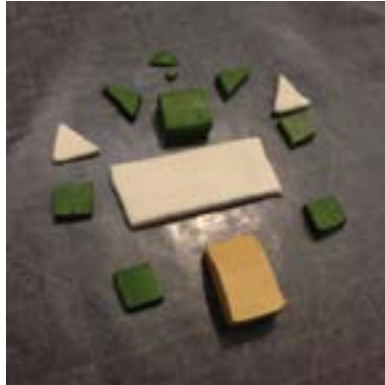

- 2** Wrap the cloak around the torso.



- 3** Cut the hands and feet as shown.



- 4** Cut wedges to fit the ears in and start placing the face.



- 5** Shape the ears, head, arms, hands and feet to your liking.



- 6** Use a toothpick to make the pupils and add detail like hair. Get creative and make a staff or a lightsaber!





# IMPERIAL PROBE DROID MARIONETTE CRAFT TEMPLATE

## HEAD

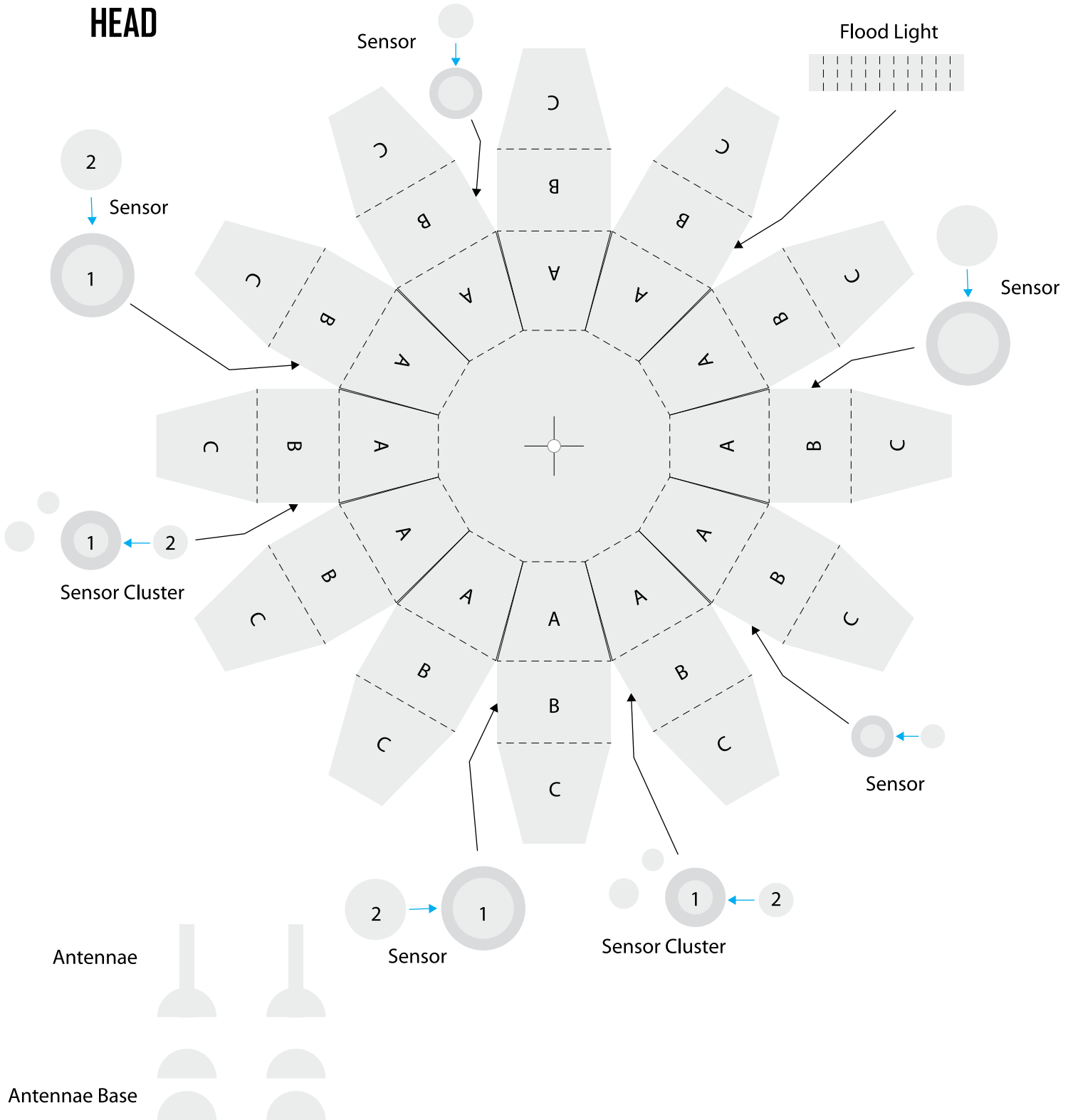



# IMPERIAL PROBE DROID MARIONETTE CRAFT TEMPLATE

## MAIN BODY

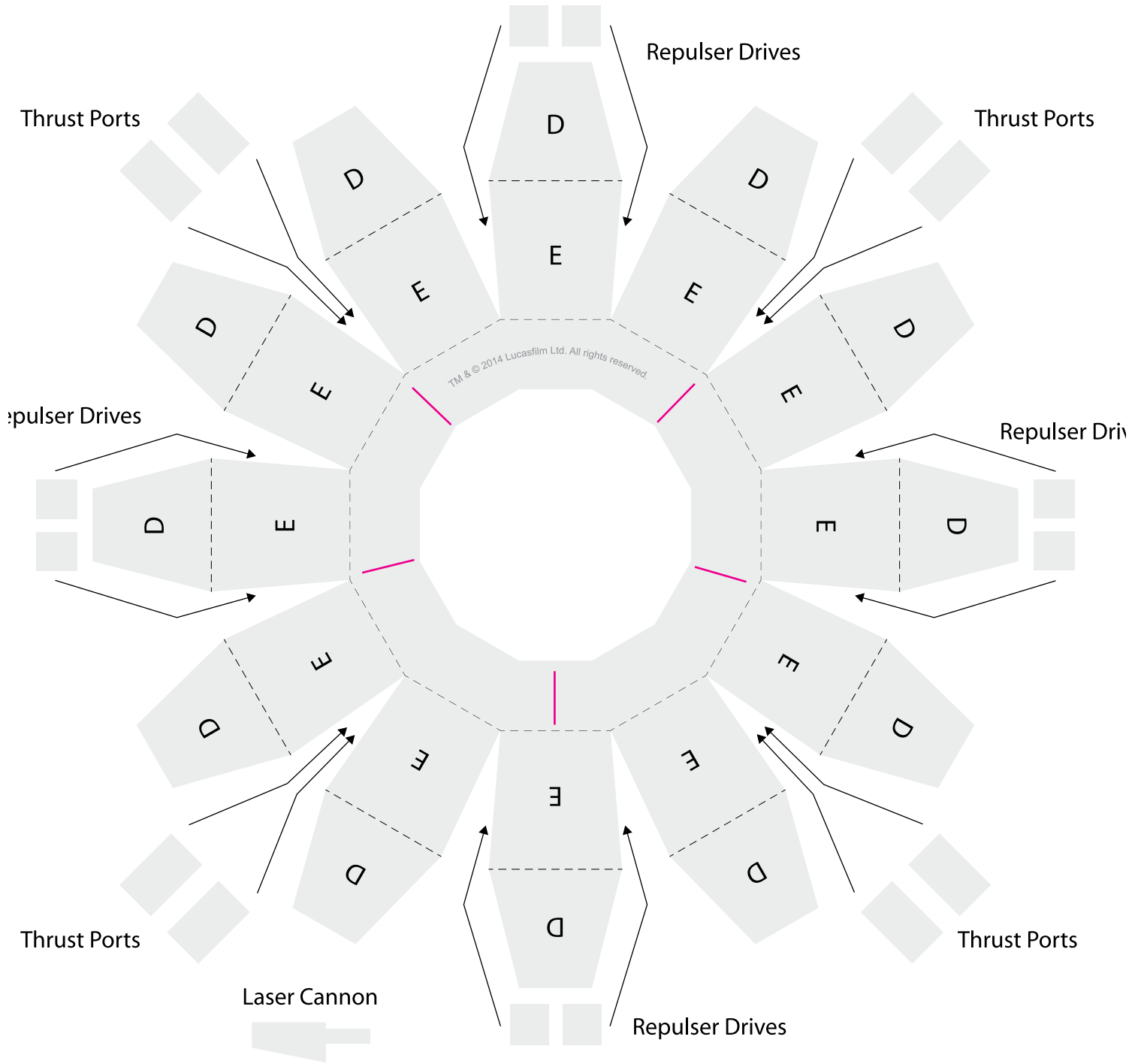



# IMPERIAL PROBE DROID MARIONETTE CRAFT TEMPLATE

Arm Joint 1



Arm Joint 2



Arm Joint 3



Arm Joint 4



Arm Joint 5

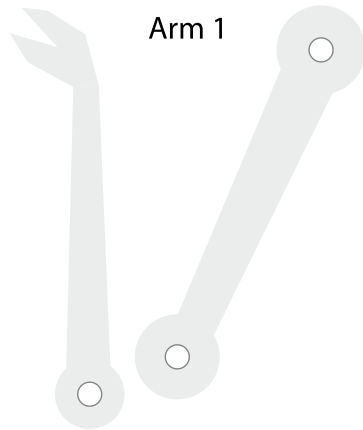

Arm 1

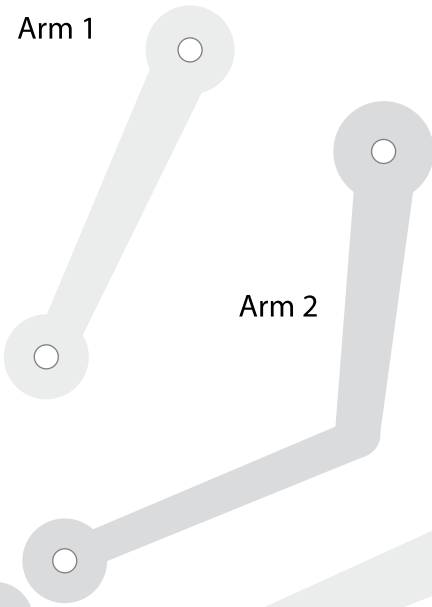

Arm 2

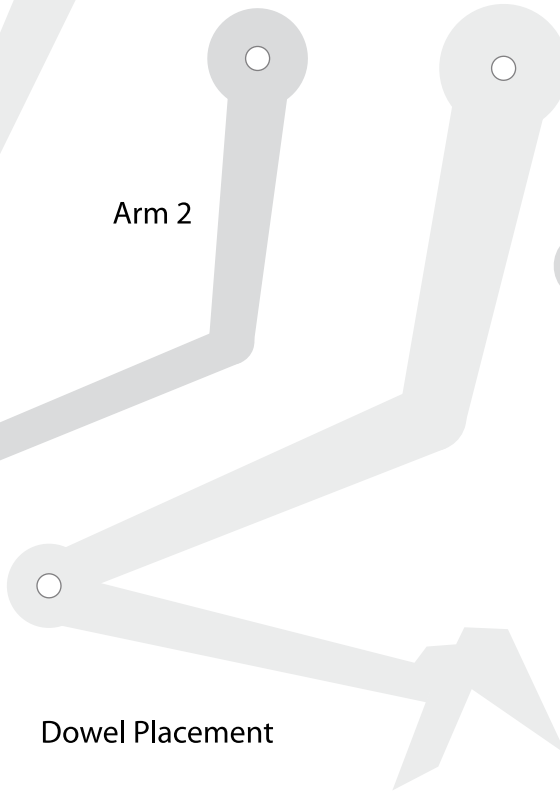

Arm 3

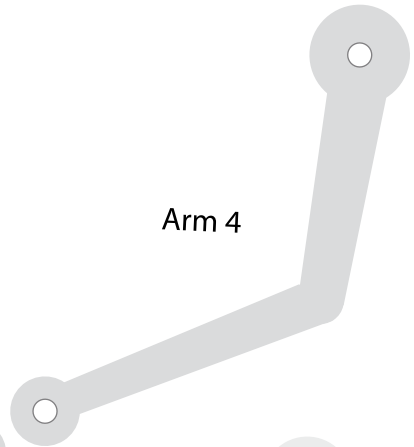

Arm 4

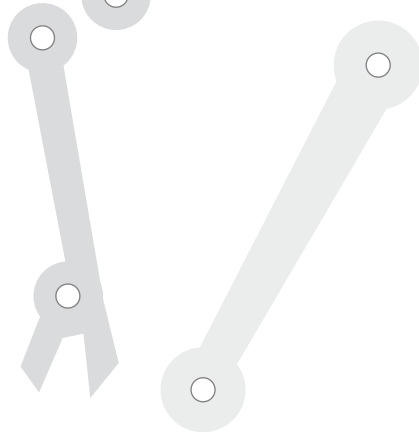

Arm 5

Dowel Placement

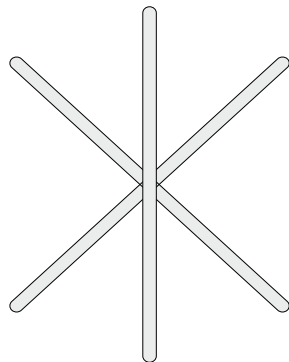



# IMPERIAL PROBE DROID MARIONETTE CRAFT TEMPLATE



## MATERIALS NEEDED:

- PDF template
- 3 12" in x 12" in piece of heavy card stock or thin chipboard.
- transfer paper or carbon paper
- ball point pen
- burnisher or dried-out ball point pen
- heavy duty crafting scissors
- craft knife with extra blades
- straightedge or ruler with cutting rail
- self-healing cutting mat
- hot melt glue gun and extra glue sticks
- 1 paper clip
- kite string (alternatively you can use strong thread or fishing line)
- 3 12" in long dowels (3/16" in around is ideal but you can use something similar)
- small hole punch (1/8" in)
- scotch tape
- Dark gray or metallic black spray paint
- newspaper or ground cloth

**WARNING:** Cutting, hot-melt gluing, and spray painting is intended for adults only. Take great caution when cutting using a cutting mat and a cutting rail ruler. Keep these and all other materials out of the reach of children at all times and never leave them unattended for any reason. If for any reason you do not feel comfortable using these materials, please do not attempt to make this craft. We want you to have fun, but at all times safety must be the #1 priority.

## INSTRUCTIONS:

**1** Print the template and place each of the first 3 pages on its own 12" in x 12" in piece of heavy card stock or chipboard. Slip a piece of carbon or transfer paper between each sheet of card stock and the corresponding template and tape it them all down so they do not move. Trace over each line with a ball point pen using a straight edge or a ruler for the straight lines. Make sure to do this on a hard surface, like a table, taking care to add the internal details as closely as possible including dotted lines, circles, etc. Now take a burnisher or a dried out ball point pen and score every dotted line using a straight-edge or a ruler.

**2** Set the cardboard on your self-healing cutting mat and using a new blade, carefully cut out each element along the solid lines using your craft knife and making sure you do NOT cut any dotted lines. Alternatively you may use heavy-duty crafting scissors provided your card stock isn't too thick. For the inner-circles on the arms and arm joints use the 1/8" in hole punch. Use a craft knife to cut the cross hairs in the center of the headband then cut away the center circle so string may pass through.





# IMPERIAL PROBE DROID MARIONETTE CRAFT TEMPLATE

- 3** Fold and bend all dotted lines and then carefully use a modest amount of hot-melt glue along the seams to create the Head piece. Start by gluing parts A together, then B together, and finally C together. You should have a hamburger shaped Head when completed. Next glue the Main Body together starting with parts E, and then parts D.
- 4** Before gluing the Head and Main body together, thread your string through the top of the head at the center of the small cross-hair {+}. Feed your string through and tie it to the paper clip so the paper clip is on the inside of the head piece when you glue it closed. Give yourself more string than you need so you can size it to fit later. If desired you may want to glue the paper clip and knot to the inside of the Head piece to keep it from becoming loose.
- 5** Now add a moderate amount of glue around the top edge (part D) of the Main Body and press the Head down so the two main shapes stick together. Flip the combined Head and Main Body over and hot-melt glue the thin, flat ends of the arm joints to the bottom where indicated by the pink lines on the Main Body piece on page 2.
- 6** Now hot-melt glue all Sensors and Sensor Clusters on panels B on Head template on page 1 as designated. Hot-melt glue the laser canon on any part A of your choice on the Head.
- 7** Glue the “D” shaped Antennae base to either side of each antennae and glue them together on the very top of the head between the center cross-hairs and the part A panel.
- 8** If you do not want to spray paint your model, skip to step 9. Lay out some newspaper or a drop cloth outside in a well ventilated area, shake well, and lightly spray all the cardboard pieces you have cut out. Allow for drying time the paint can’s instructions and when dry turn the parts over and reapply paint lightly until all sides are well covered and even. Once completely dry go on to step 9.
- 9** Hot-melt glue 3 12" in dowels together as shown in the Dowel Placement illustration on Page 3. This will be your marionette control. Tie the center line of string you threaded earlier to the center of the dowels leaving about 10" in to 12" in of clearance between the top of the head and the bottom of the marionette control.
- 10** Loosely tie each arm together as grouped on Page 3, and loosely tie the arm base to the corresponding Arm joint.  
*Note: If you tie too tight the arms will lack movement. If you tie too loose you will get your arms tangled up. Play with the amount of space you need between joints until it seems right to you. Then tie a generous amount of string to any arm that has a punched hole. Each arm will connect to its own dowel. For arms without a punched hole near the claw, you may tie the string to the upper arm joint. Take care to space the arms apart so that they do not cross strings. Hang some higher and some lower but take care not to raise the arms higher than the arm joints. Also, take care not to allow too much slack in the line as tangling will occur. Once you have found the right length tape or tie the string to the dowel.*
- 11** **You’re finished!** Now show off your skills by rocking the marionette control left, right, back and forth to make your puppet come alive



# STAR WARS INKJET SHRINK PAPER CHARMS

Print on inkjet compatible shrink paper, cut out, punch holes where indicated, and follow instructions on packaging for baking instructions.

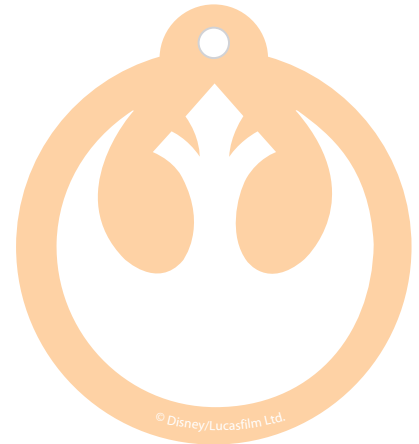
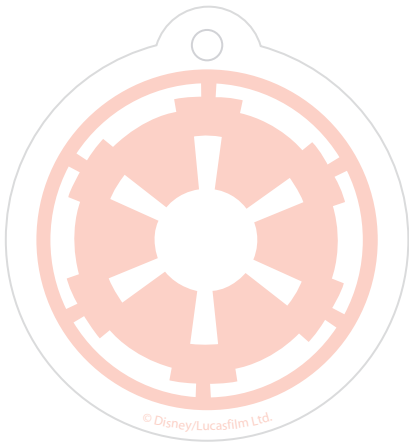



# PARTY INVITE CARDS

Print the invitations and cut them out. Fill in the information and get ready for the party!





# THANK YOU CARDS

Print the thank you cards and cut them out. Fold along the dotted lines. Write your thankful note and send to family and friends.





# TIE FIGHTER PIÑATA



## MATERIALS NEEDED:

- All-purpose flour
- Cold water
- Sugar
- Newspaper
- Large, round balloon
- Silver tissue paper
- Black electrical tape
- String
- Glue stick
- Hot Glue Gun
- Paper Towel Tube
- Foam Core Board or Cardboard
- Tape Measure
- Black marker
- Candy

## INSTRUCTIONS:

**1 Make your papier-mâché paste:** Combine 1/2 cup of all-purpose flour and 2 cups of cold water in a bowl. Mix them together. Add mixture to a saucepan of 2 cups of boiling water and bring back up to a boil. Remove from heat and stir in 3 tablespoons of sugar. Let it cool. Once cool and thick it will be ready to use.

**3** Apply your first layer of papier-mâché by applying your papier-mâché paste to stripes of newspaper with your hands and placing them onto the balloon. Have your strips overlap slightly to create a stronger surface. Cover the whole balloon except a 2 inch square around the knotted end. After applying 2-3 layers of papier-mâché to the balloon, let dry for 24 hours.

**2** Inflate your large balloon. Tear your newspaper into 2-inch-wide strips (torn instead of cut will give you a smoother finish).

**4** Cut your silver tissue paper into 2-inch strips. Apply the strips of the silver tissue paper to the balloon with papier-mâché paste. 2 layers or until you can't see the newspaper underneath. Let it dry.



# TIE FIGHTER PIÑATA

- 5** Using your tape measure cut your foam core board or cardboard into two hexagons for the wings. Draw a 1/2" in thick line from each corner; this will create the triangle areas. Fill the triangles with black electrical tape. Use glue stick to glue silver tissue paper to the empty areas between the black electrical tape triangles. (See pictures) Repeat this step to both sides of your two wings.

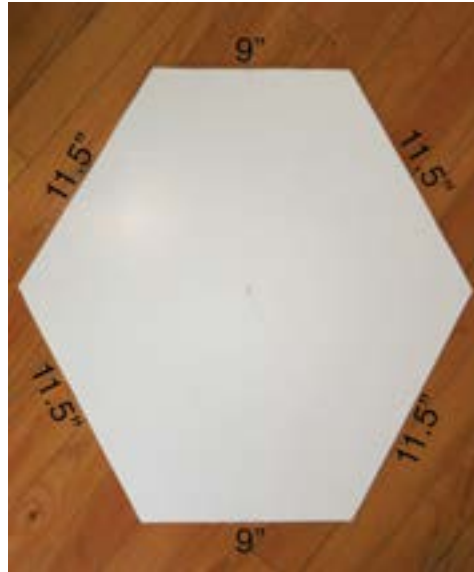

- 6** Cut two 2-inch pieces from your paper towel tube. Cover them with silver tissue paper using the glue stick.

- 8** Hot glue your paper towel tube cutouts to the center of your wings. Once dry, hot glue your wings to the sides of your balloon (one should cover the hole from where your balloon was).

- 10** **To insert candy:** cut a small square into the back and put in your candy. Once filled patch up the hole with silver tissue paper and papier-mâché paste.

- 7** On your balloon using a black marker draw the windows on the front of your TIE. Pop the balloon and remove it. (Be sure papier-mâché is completely dry before performing this step).

- 9** Cut two small slits into the top of your piñata to attach your string.

- 11** Once your patch is dry, **it's time to play.**



# DEATH STAR CAKE POPS



## MATERIALS NEEDED:

- Baked cake (your favorite box mix)
- 1 can of frosting (your favorite flavor)
- Candy coating in black and white
- Lollipop sticks
- Parchment lined baking sheet
- Small ziploc bag or decorating bag
- Brick of styrofoam  
(or some type of cake pop display)

## INSTRUCTIONS:

- 1** Bake your cake according to box instructions and set aside to cool.
- 2** Crumble your cake finely into a bowl, throwing out any hard edges that won't crumble. Spoon in 1/2–3/4 of frosting and use your hands to mix it together with your crumbled cake.
- 3** Using your hands, scoop out small portions of cake and roll them into balls and place them on your parchment lined baking sheet. Once all your cake is shaped, pop them into the refrigerator for 20 min.



# DEATH STAR CAKE POPS

**4** Melt a mix of the white and black candy coating to achieve your favorite “Death Star Grey”. Save some black candy coating for decorating.

**6** Melt some black candy coating and let it cool to a temperature you can touch but before it’s a solid. Then put it in your decorating bag or ziploc bag.  
*Note: if using a ziploc bag, cut a tiny hole at the corner of the bag. Instant decorating bag.*

**5** Remove 3 or 4 cakes from the refrigerator at a time to dip. Take a lollipop stick and dip the very top into your candy coating (it will act like glue to keep your lollipop stick in your cake), then insert your lollipop stick into the bottom of the cake. Dip your pop into the coating, submerging the cake completely. Try not to swirl because your cake may fall apart in the icing. Let any extra coating drip back into the bowl and set aside to dry.

**7** Using the black candy coating in your bag, decorate your dry cake pops. One filled-in circle for your super laser and little lines for texture.

**8** Let dry and enjoy! Your Death Star cake pops are now fully operational and yummy.







# GRILLED CHEESE AND HAM SOLO SANDWICH

## TEMPLATE

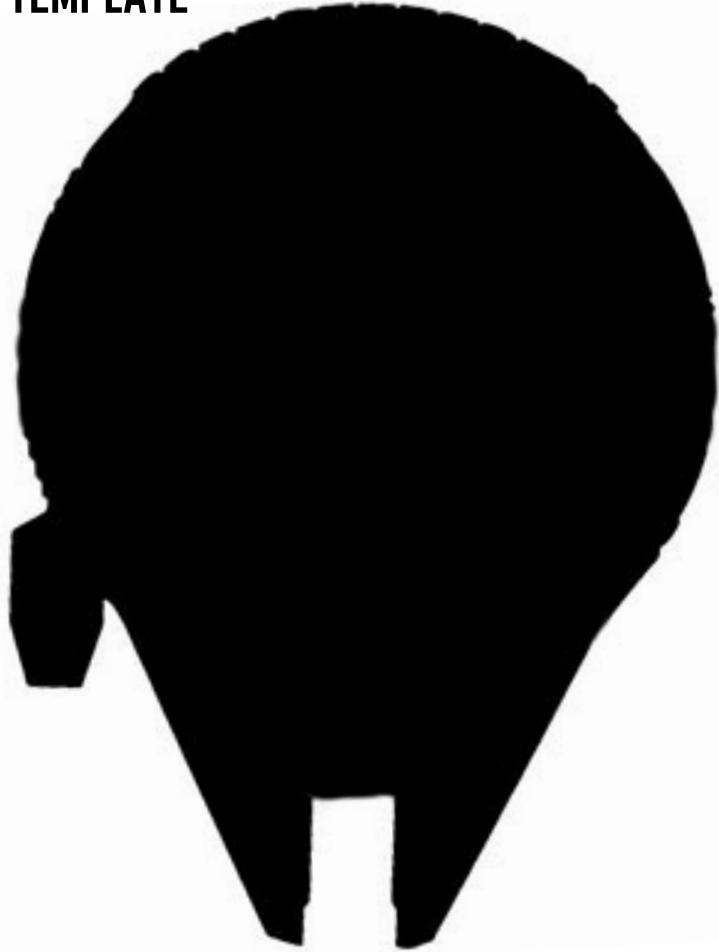

### MATERIALS NEEDED:

- Bread of your choice
- Ham slices
- Cheese of your choice
- Butter
- Millennium Falcon Cutout

### INSTRUCTIONS:

- 1 Spread butter on the outer sides of your bread slices.
- 2 Fill your sandwich with layers of cheese and ham.
- 3 Grill each side of the sandwich in a large skillet over medium-high heat. Once both sides are golden brown and your cheese is melted, remove from heat and let it cool a little.
- 4 Place Millennium Falcon cutout on top of the sandwich and cut your sandwich to match.
- 5 Now you have the yummiest hunk of junk in the galaxy.





# FELT CHEWBACCA BOOKMARK

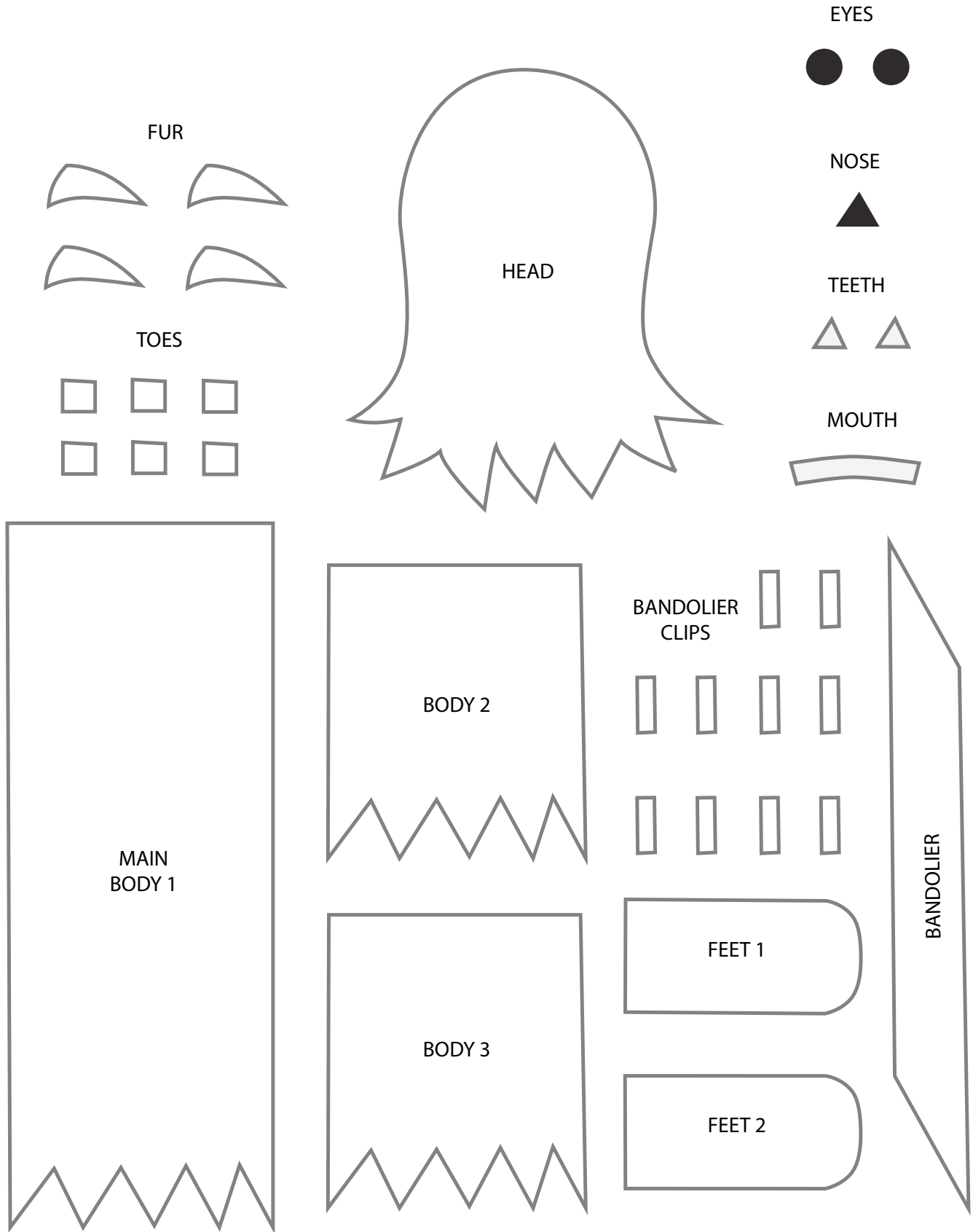



# FELT CHEWBACCA BOOKMARK

## INSTRUCTIONS:

- 1 Print out and cut out all the pieces from page 1.
- 2 Use the cut out pieces to trace on top of the felt material with a thin marker then cut.
- 3 Assemble the HEAD as follows:
  - put the EYES, NOSE, TEETH, and MOUTH on top of the head.
  - use glue or double-sided tape to assemble.
  - place the FUR around the top like the image.
- 4 Assemble the BANDOLIER as follows:
  - glue down the BANDOLIER CLIPS on top of the belt.
  - make sure that BANDOLIER is facing up before gluing.
- 5 Assemble the FEET as follows:
  - glue TOES to the rounded side of the FEET as pictured.
- 6 Lastly, assemble the BODY:
  - glue BODY 2 to the middle of the MAIN BODY.
  - glue BODY 3 to the top of the MAIN BODY.

**Tip:** MAIN BODY can be cut longer for a longer bookmark!

- 7 Glue BANDOLIER on top of the body once assembled.
- 8 Glue HEAD on top of body & BANDOLIER.
- 9 Glue the FEET behind the body as pictured, and you're done!

